

PCG364NL

36-INCH GAS RANGETOP WITH GRILL

PROFESSIONAL SERIES, PORCELAIN COOKTOP SURFACE



FEATURES & BENEFITS

- ★ - Patented Pedestal Star® Burner with QuickClean Base® designed for easy surface cleaning and superior heat spread for any size pan
- ★ - Precision simmering capabilities as low as 100°F (375 BTU) with 2 ExtraLow® Simmer burners
 - 18,000 BTU (NG) Star® Burners
 - Superior grill results—1,630 Watt indoor electric grill
 - Non-stick, rust-proof cast-aluminum grill with fusion coated surface, removable for easy cleanup

ACCESSORIES (OPTIONAL)

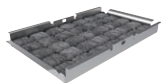

PABRICKBKN
Black Ceramic Briquettes with Basket

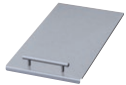

PA12LCVRN
12" Pro Grill Cover for Indoor Electric Grill

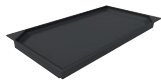

PAGRIDDLEN
12" Pro Griddle



PAGRIDDLE
Griddle



PA12CHPBLK
12" Cutting Board



PWOKRINGHC
Wok Ring



PA36GLBC
12" Low Backguard



PAKNOBLUNH
Blue Knob Kit



PALPKITHN
LP Conversion Kit

GENERAL PROPERTIES

Controls	Metal Knobs
Sealed Burners	Yes
Grate Material	Cast Iron

BURNER PERFORMANCE

Total Number of Cooktop Burners	4
Power of Front Left Burner (NG)	18,000 and XLO
Power of Back Left Burner (NG)	18,000 and XLO
Power of Back Center Burner (NG)	N/A
Power of Front Center Burner (NG)	N/A
Power of Center 12" Electric Griddle (W)	N/A
Power of Center 12" Electric Grill (W)	1,630 W
Power of Back Right Burner (NG)	18,000
Power of Front Right Burner (NG)	18,000

TECHNICAL DETAILS

Circuit Breaker (A)	20 A
Volts (V)	120 V
Frequency (Hz)	60 Hz
Plug Type	120V-3 Prong NEMA 5-20
Power Cord Length (in)	72"
Energy Source	Gas
Gas Type	Natural Gas 15 mbar (USA)
Alternative Gas Type	LP 27.4 mbar (USA)
Convertible To LP (Kit Required)	Yes

DIMENSIONS & WEIGHT

Overall Appliance Dimensions (H*xWxD) (in)	10 9/16" x 35 15/16" x 25 13/16"
Required Cutout Size (HxWxD) (in)	7 11/16" x 35 1/8" x 22 13/16"
Minimum Distance From Rear Wall (in)	12" min to combustible surface with Flush Island Trim
Net Weight (lbs)	155 lbs

ACCESSORIES (INCLUDED)

1 x Island Trim

WARRANTY

Limited Warranty, Entire Appliance, Parts and Labor	2 Year
---	--------

*Height Includes Gas Connection

PCG364NL
36-INCH GAS RANGETOP WITH GRILL
 PROFESSIONAL SERIES, PORCELAIN COOKTOP SURFACE



36-INCH RANGETOP AND CUTOUT DIMENSIONS

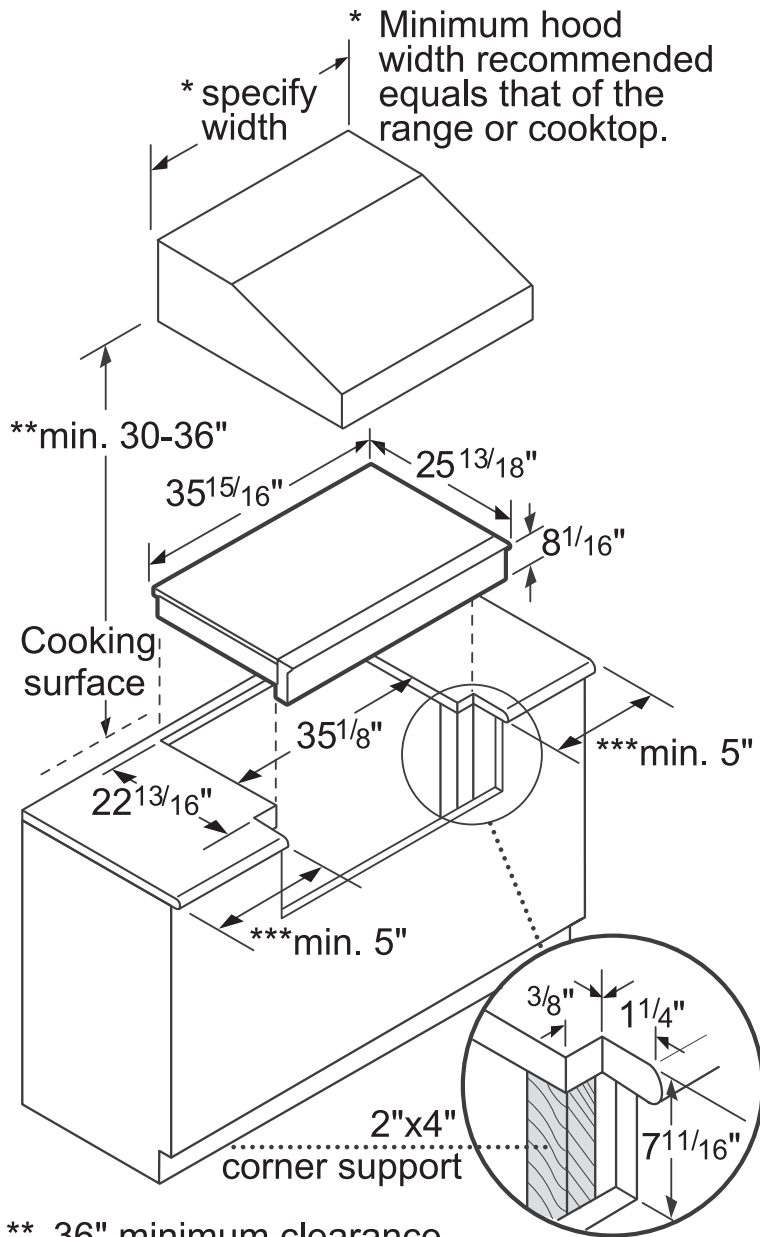

** 36" minimum clearance from cooking surface to combustible surfaces.

***5" minimum clearance from cooking surface to combustible side wall.

Note: Most hoods contain combustible components that must be considered when planning the installation.

measurement in inches

36-INCH RANGETOP CLEARANCE REQUIREMENTS

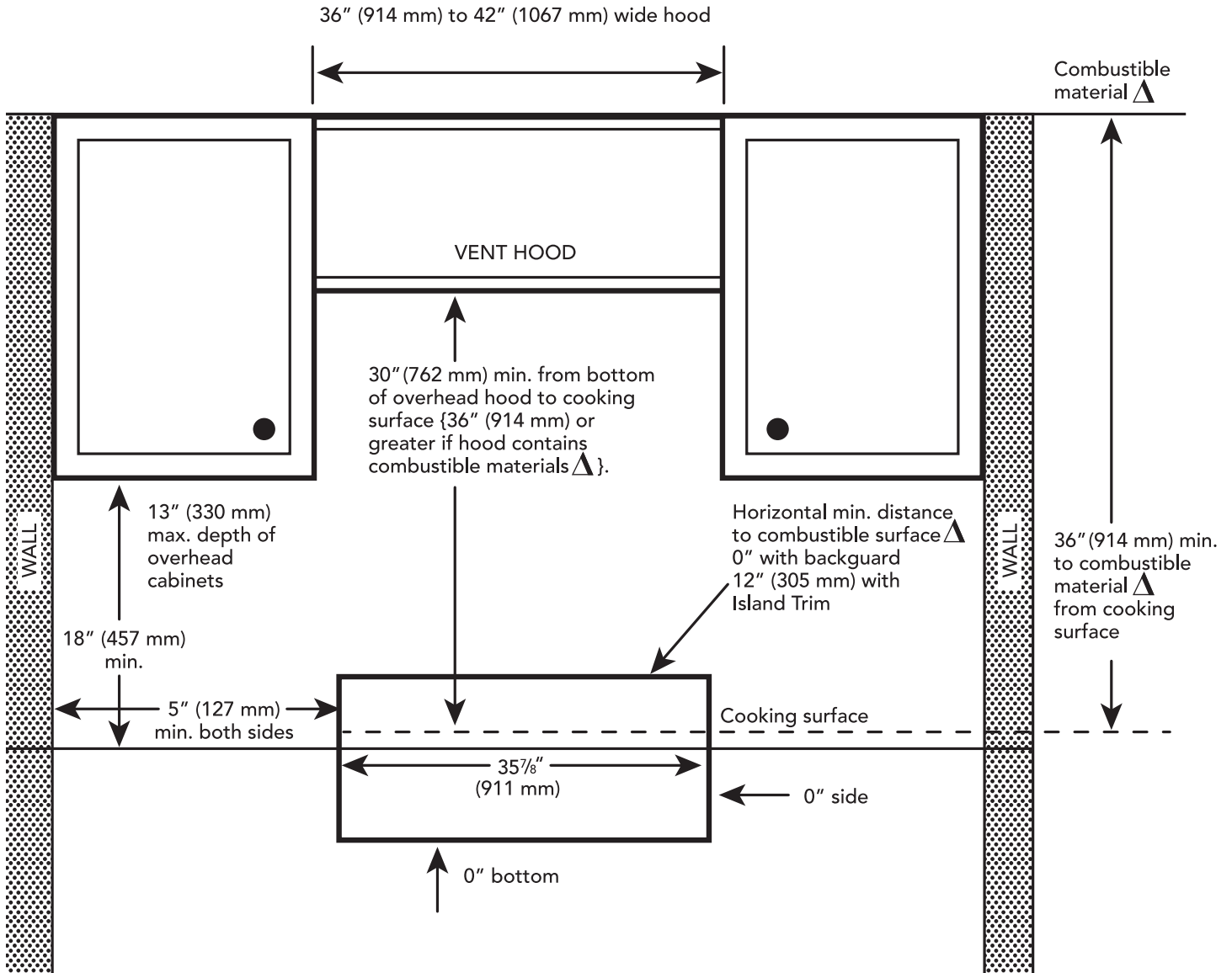

Clearances Requirements

▲ as defined in the "National Fuel Gas Code" (ANSI Z223.1, Current Edition). Clearances from non-combustible materials are not part of the ANSI Z21.1 scope and are not certified by CSA. Clearances of less than 12" (305 mm) must be approved by the local codes and/or by the local authority having jurisdiction.

NOTE: A 36-inch minimum clearance is required between the top of the cooking surface and the bottom of an unprotected cabinet. A 30-inch clearance can be used when the bottom of the wood or metal cabinet is protected by not less than 1/4 inch of a flame retardant material covered with not less than No. 28 MSG sheet steel, 0.015 inch (0.4 mm) thick stainless steel, 0.024 inch (0.6 mm) aluminum, or 0.020 inch (0.5 mm) thick copper.

PCG364NL

36-INCH GAS RANGETOP WITH GRILL

PROFESSIONAL SERIES, PORCELAIN COOKTOP SURFACE



ELECTRICAL AND GAS LOCATIONS

The gas and electrical supply must be located in an area that is accessible without requiring removal of the rangetop. The appliance electrical power cord and gas pipe connection are located on the left rear underside of the rangetop.

The junction box must be located within 3 feet (~900 mm) of the rangetop connection.

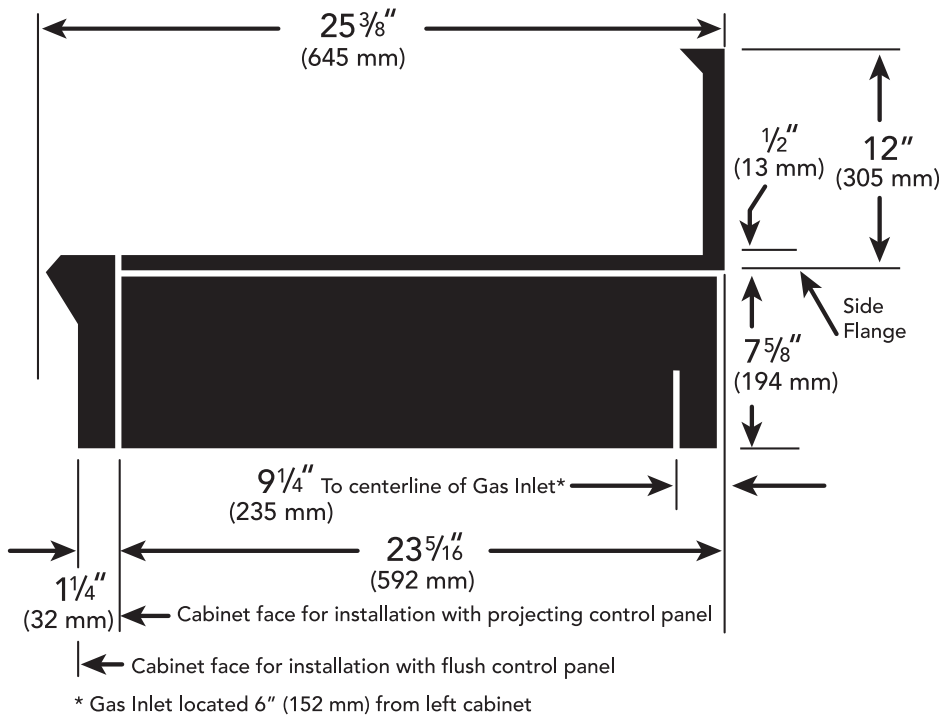

NATURAL GAS REQUIREMENTS:

Inlet Connection: 1/2" NPT (min. 3/4" dia. flex line)
 Supply Pressure: 6" min. to 14" max. water column (14.9 mb to 34.9 mb)
 Manifold Pressure: 5" water column (12.5 mb)

PROPANE GAS REQUIREMENTS:

Inlet Connection: 1/2" NPT (min. 3/4" dia. flex line)
 Supply Pressure: 11" min. to 14" max. water column (27.4 mb to 34.9 mb)
 Manifold Pressure: 10" water column (24.9 mb)

ELECTRICAL SUPPLY

IMPORTANT: The cord supplied with gas rangetops having a grill requires a NEMA 5-20 receptacle as shown here. Local codes may require a different wiring method.

NEMA 5-20 RECEPTACLE



PLUG

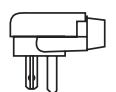

WARNING: This appliance is equipped with a three-prong grounding plug for protection against shock hazard and should be plugged directly into a properly grounded receptacle. DO NOT cut or remove the grounding prong from this plug. DO NOT ALTER THIS PLUG.

These warranties give you specific legal rights and you may have other rights that vary from state to state. Full warranty and limited warranty from date of installation. For complete warranty details, refer to your Use & Care manual, or ask your dealer.

Specifications are for planning purposes only. Refer to installation instructions and consult your countertop supplier prior to making counter opening. Consult with a heating and ventilation engineer for your specific ventilation requirements. For the most detailed information, refer to installation instructions accompanying product or write to Thermador indicating the model number. Specifications are correct at time of printing. Thermador reserves the right to change product specifications or design without notice. Some models are certified for use in Canada. Thermador is not responsible for products that are transported from the U.S. for use in Canada.